

AD1048-24FS 전원부 설치 가이드

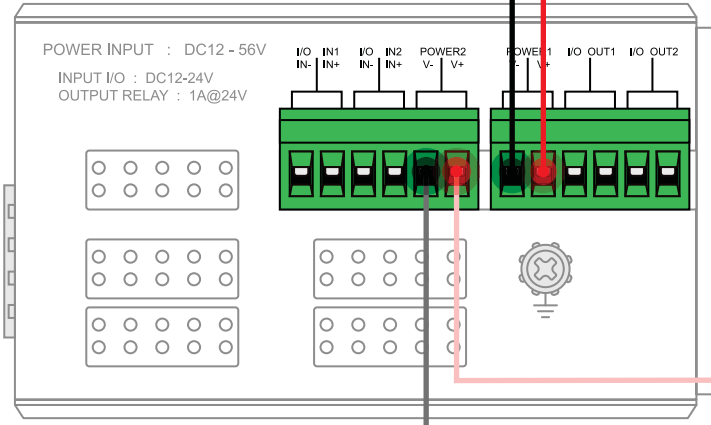



기본 설치

-  ≡ 접지선
-  N 중성선
-  L 상(HOT)

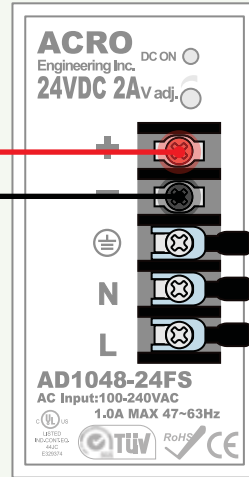







(SFC8000 / SFC8000S / SFC8000G 기준)

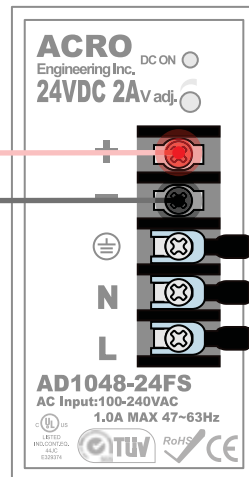

-  POWER
-  RING MODE
-  POWER INPUT 1
-  POWER INPUT 2
-  FAULT ALARM

전원이중화 필요시



-  POWER
-  RING MODE
-  POWER INPUT 1
-  POWER INPUT 2
-  FAULT ALARM

AD1240-48S 전원부 설치 가이드



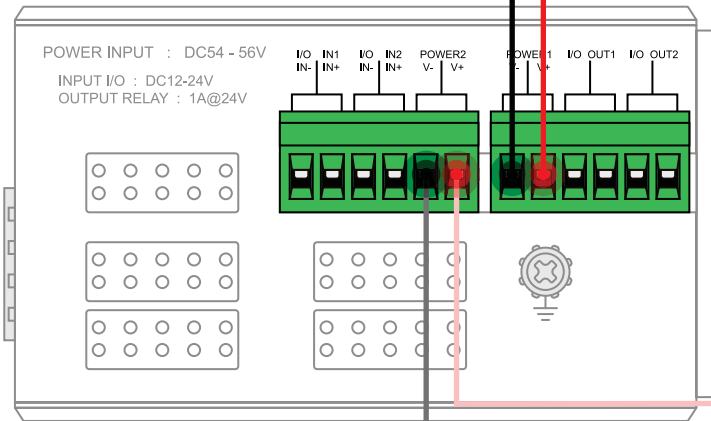

기본 설치

-  ≡ 접지선
-  N 중성선
-  L 상(HOT)

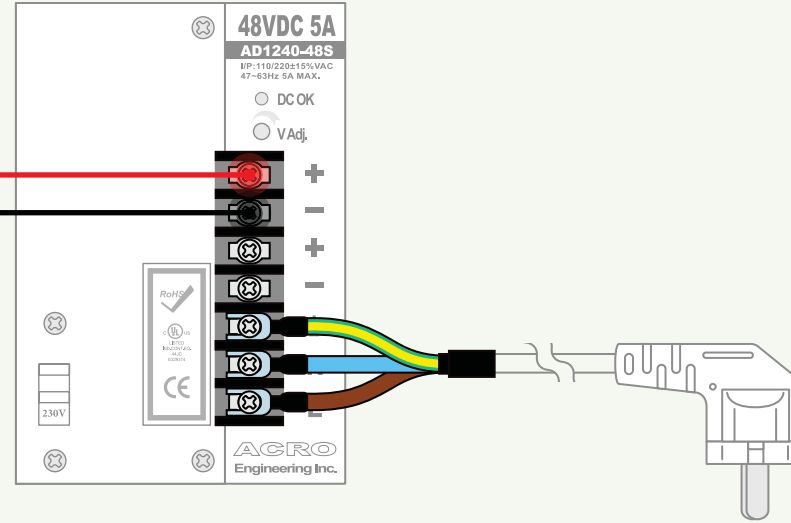







(SFC8000HP 기준)

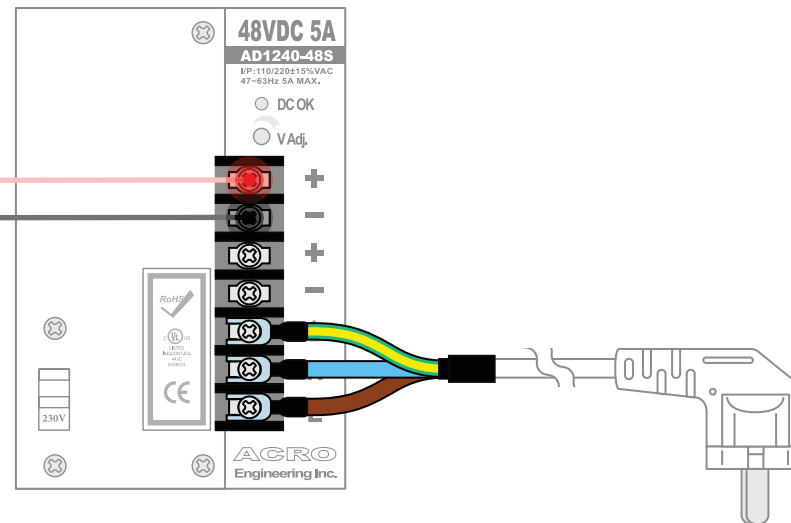

-  POWER
-  RING MODE
-  POWER INPUT 1
-  POWER INPUT 2
-  FAULT ALARM

전원이증화 필요시



-  POWER
-  RING MODE
-  POWER INPUT 1
-  POWER INPUT 2
-  FAULT ALARM